



Perimeter heating

Powerkon nano

KAMPMAN
Genau mein Klima.

Visual statement in a room

PowerKon nano units represent an attractive eye-catching feature in front of full-height glazing. The ideal solution when an elegant statement is to be made.

Proven reliability

With the market-leading technology of our trench heating units, we are combining performance and design in a freestanding radiator.

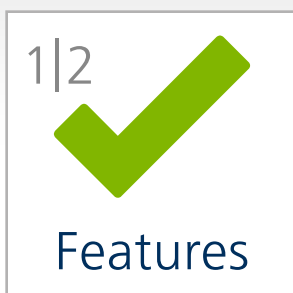

Features

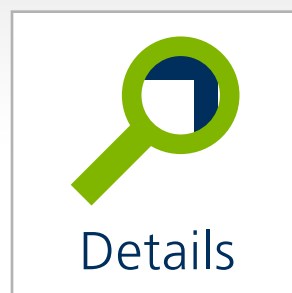

Details

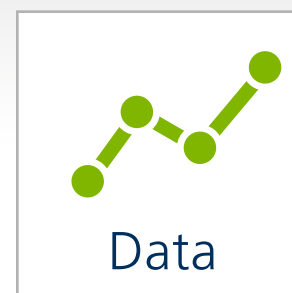

Data

Creates an ideal indoor climate

The flow-optimised air guidance, with a façade-side air outlet, ensures maximum comfort in the room. With guaranteed output measured according to EN 16430.

It's your choice

Whether for new build or refurbishments, the interaction of quietly operating EC tangential fan and high-output copper/aluminium coil delivers an optimum indoor climate with high heat output and low sound impact.

A harmonious unit

Flat, delicate, restrained! The FineLine grille was developed specifically for our smallest recirculating air fan convectors and creates a harmonious appearance that blends perfectly with every interior architectural style.

Elegant appearance

Both the FineLine grille as well as the casing are powder-coated in a RAL colour of your choice – for a complete look.

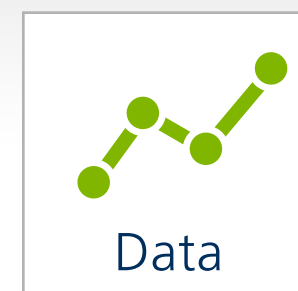
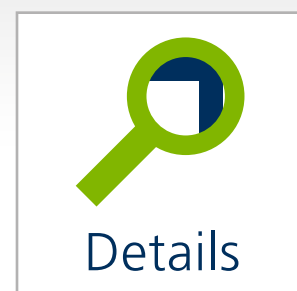
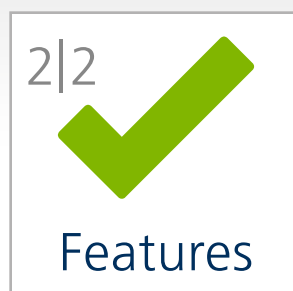

PowerKon nano at a glance

- 1 - Connection openings
- 2 - Connection: 1/2" female
- 3 - Anti-twist system
- 4 - Covered connection area
- 5 - Grille support
- 6 - High-output convector
- 7 - Extra-long EC fan
- 8 - FineLine Q: orthogonal grille, stainless steel (example)
- 9 - Powder-coated sheet steel casing

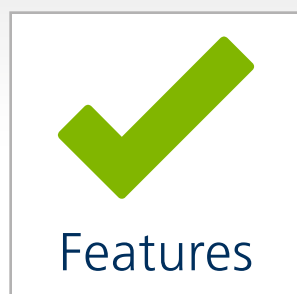
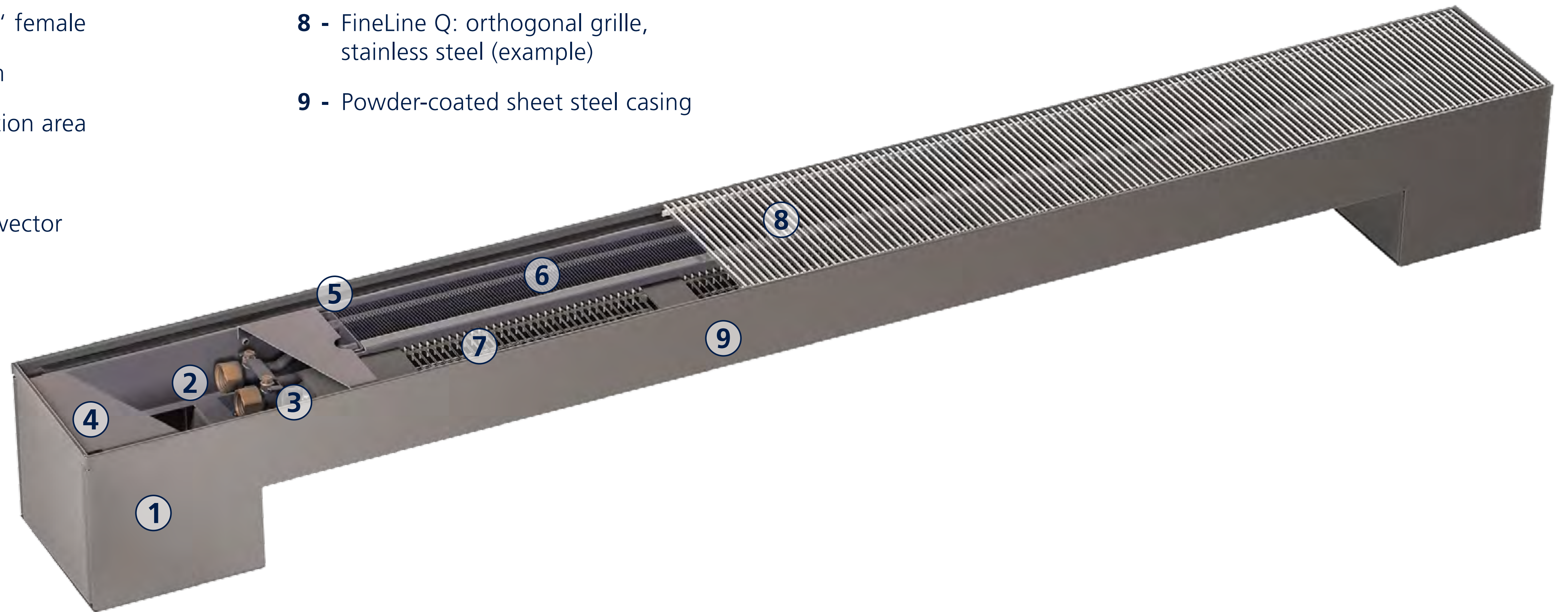

Features

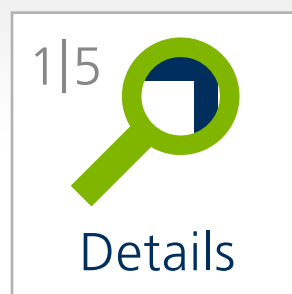

Details

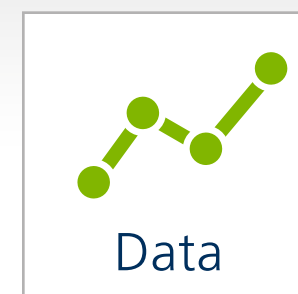

Data

Connection openings

- ▶ for precise routing of water and electrical lines



Anti-twist system

- ▶ prevents damage to the convector when installing the valves or threaded connectors

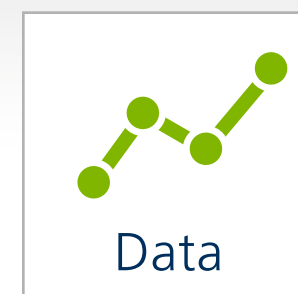
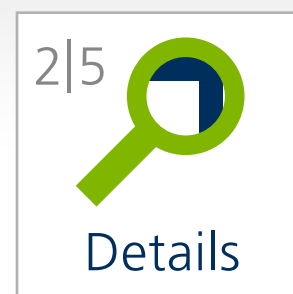
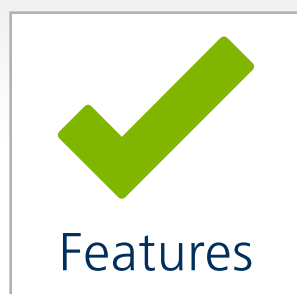

Connection area

- ▶ for valves and electrical connections
- ▶ with cover for visual protection and to protect against dirt



Electrical junction box

- ▶ 24 V electromechanical

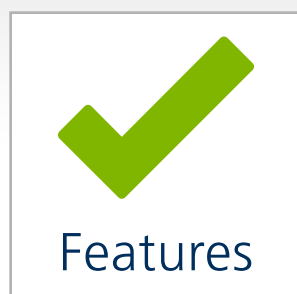
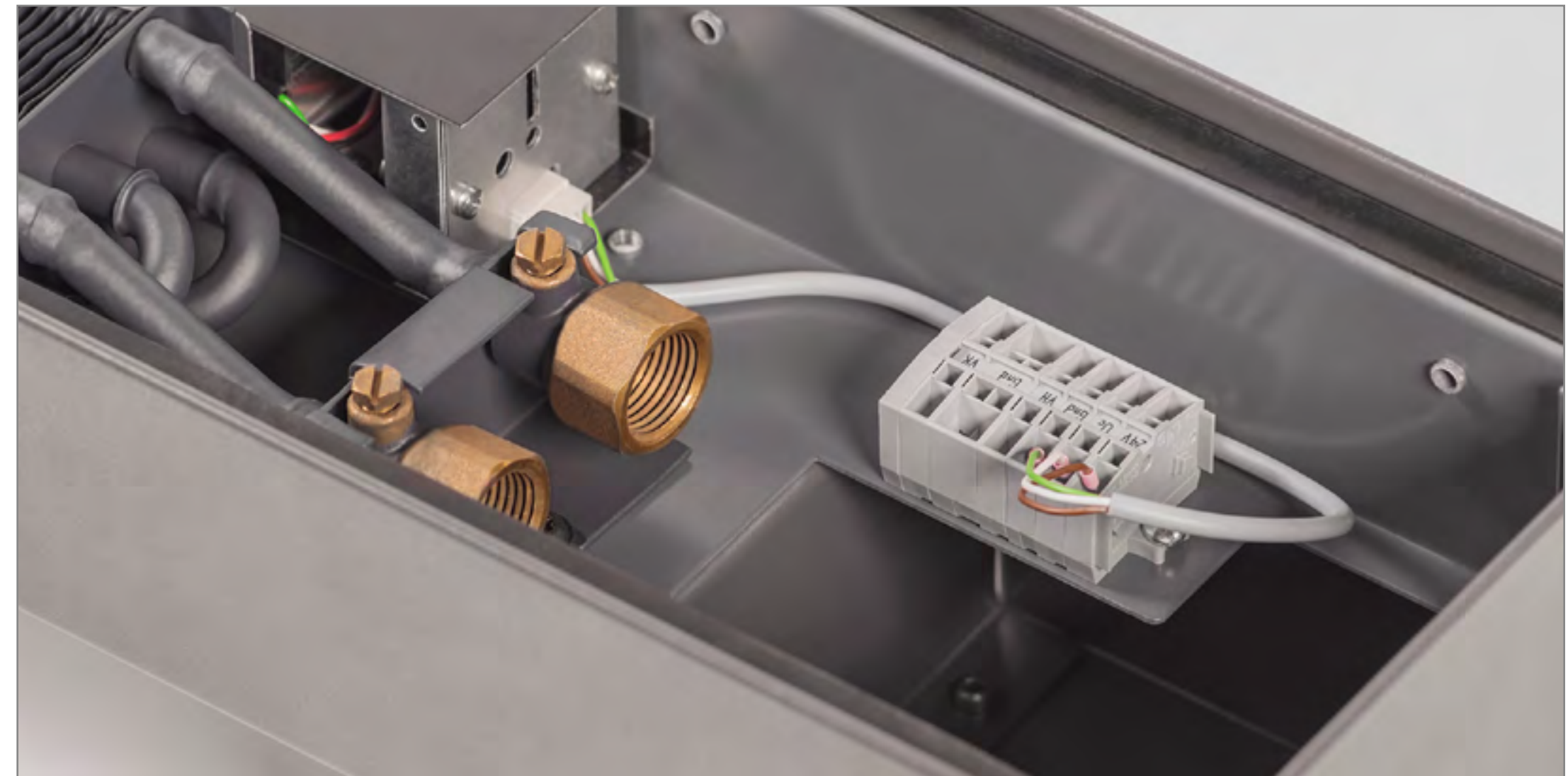

Features

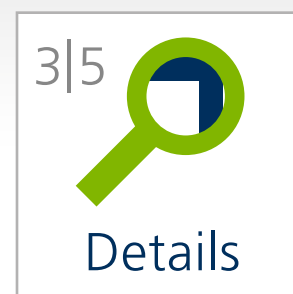

Details

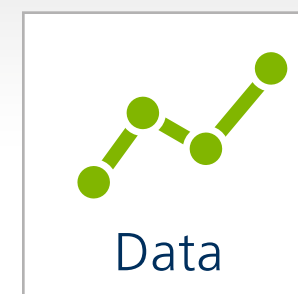

Data

Powder-coated steel casing

- ▶ standard DB703
- ▶ other colours on request, example shown RAL 9016 (traffic white)



Flush-mounted clock thermostat 24 V

- ▶ for timed control of the PowerKon nano
- ▶ valve actuator and fan control
- ▶ illuminated display
- ▶ integral room temperature sensor

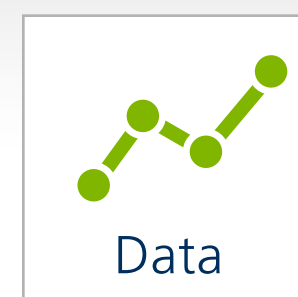
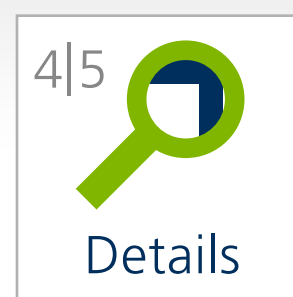
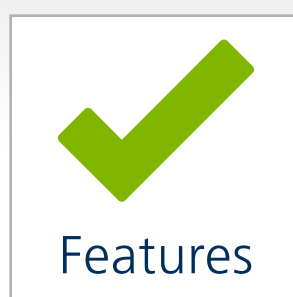

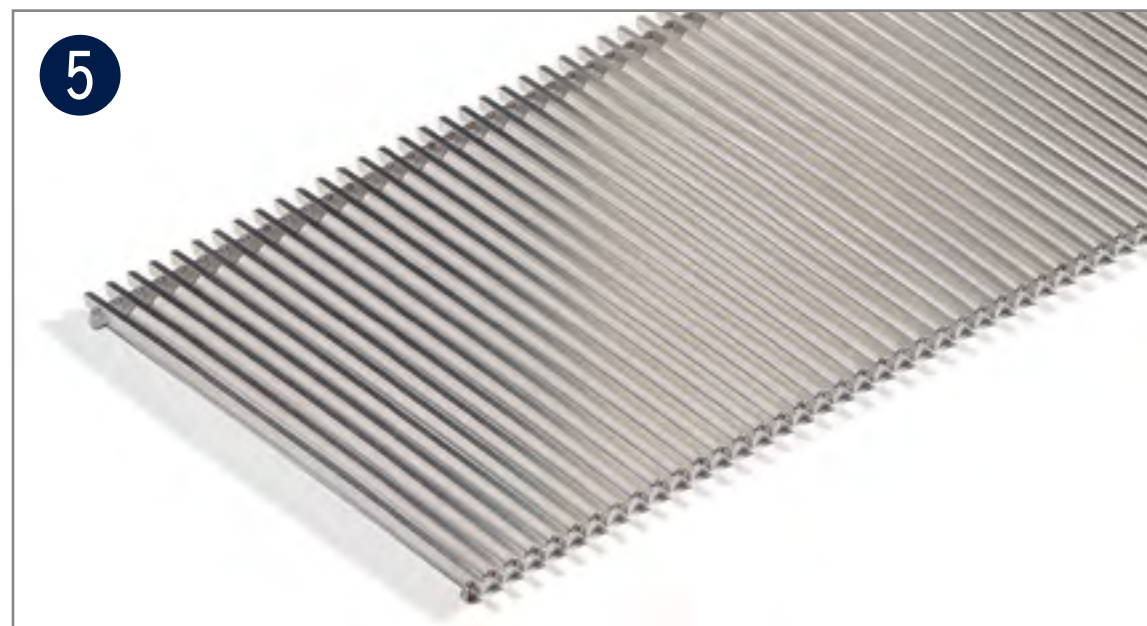
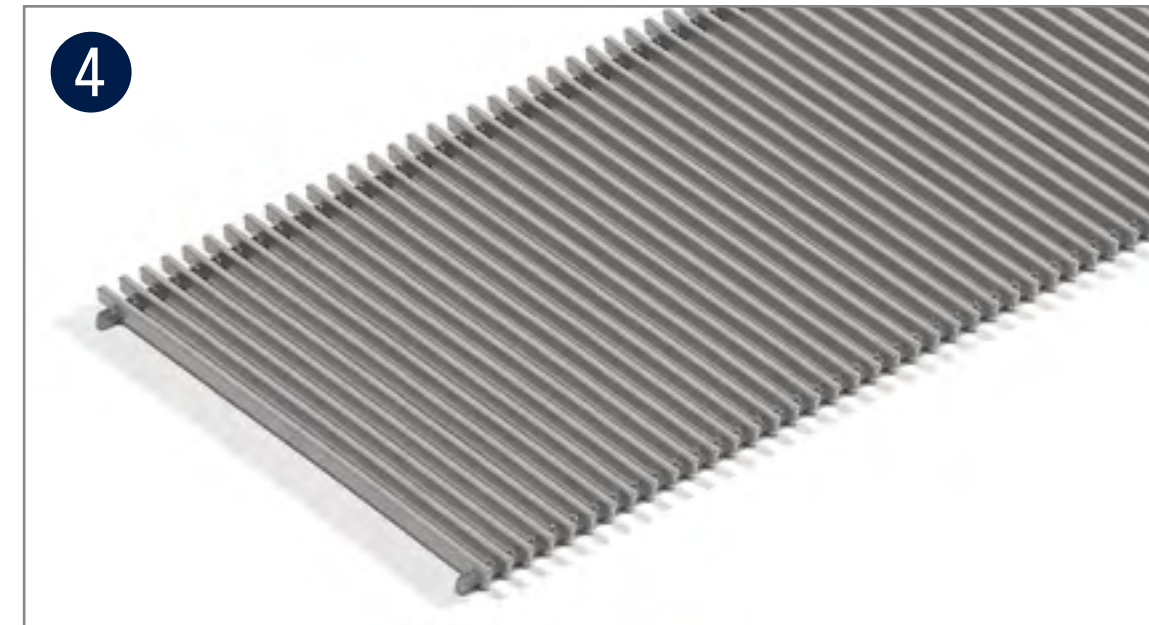
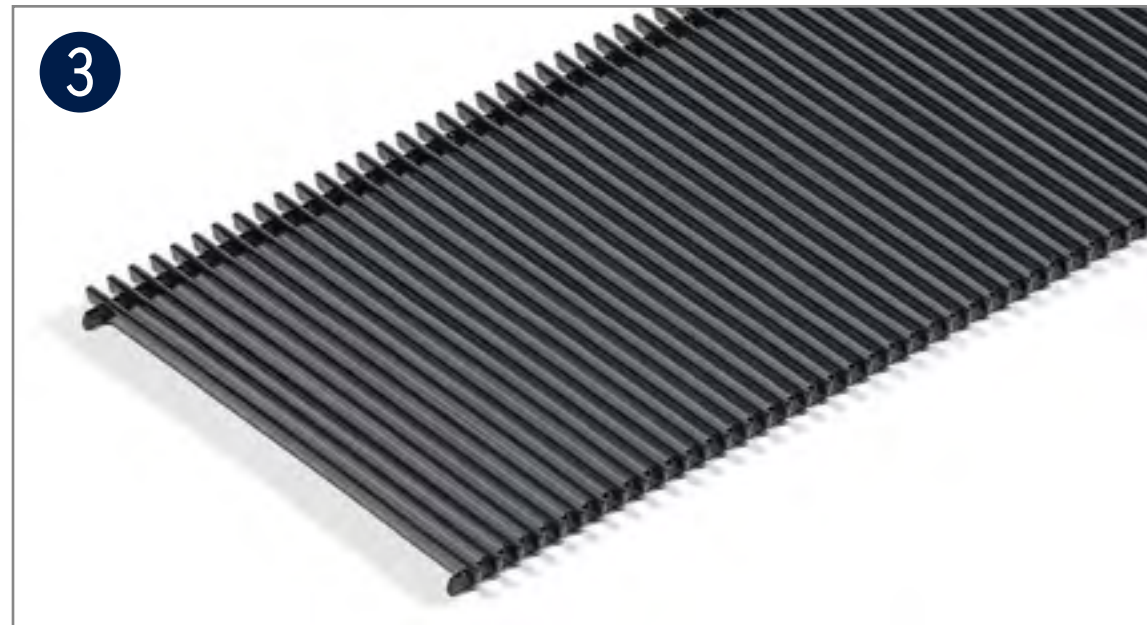
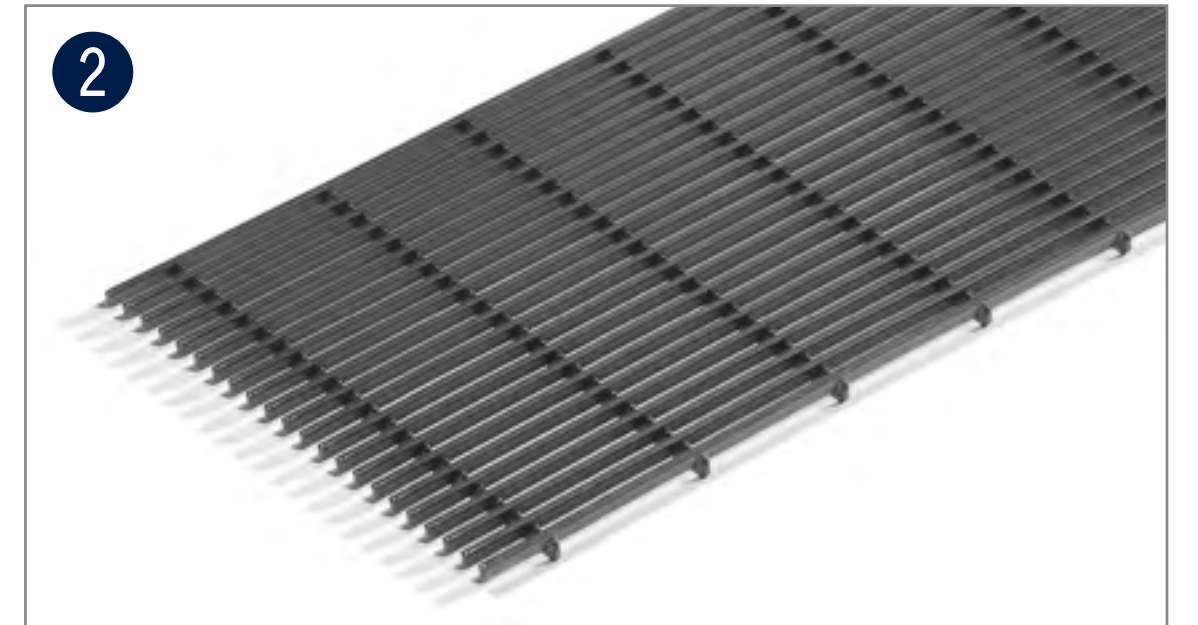
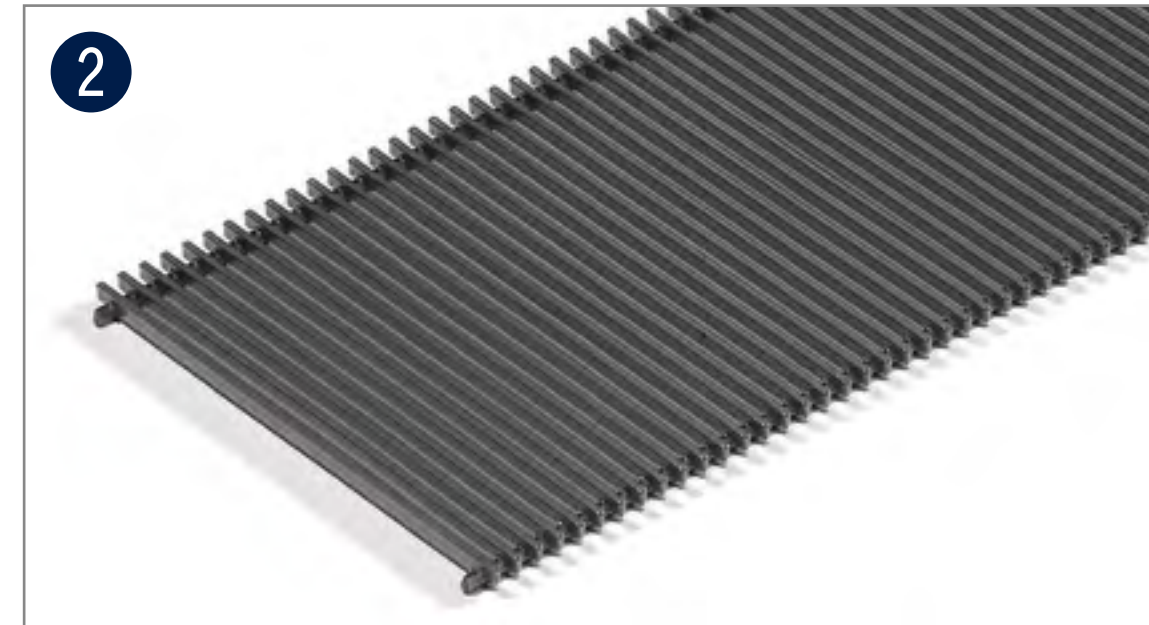
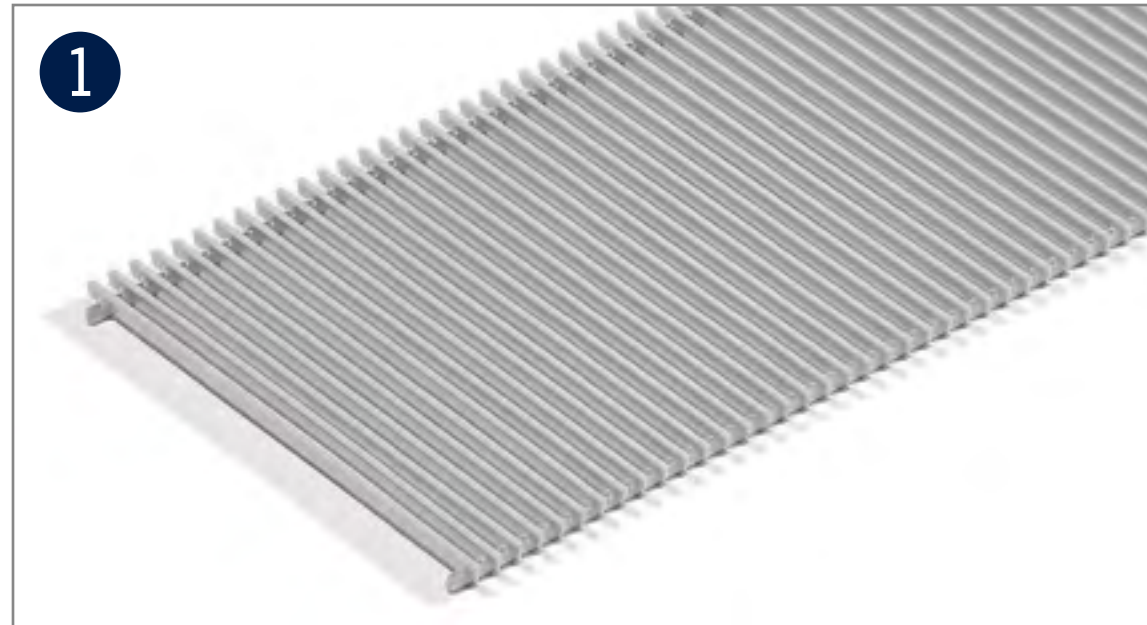

Matching grilles FineLine Q/L

- 1 Steel, powder coated, RAL 9006 (white aluminium)
- 2 Steel, powder coated DB 703 (basalt grey)
- 3 Steel, powder coated, RAL 9005 (black)
- 4 Steel, powder coated, RAL 9007 (grey aluminium)
- 5 Natural stainless steel

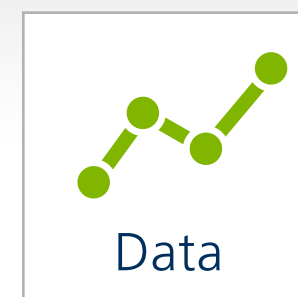
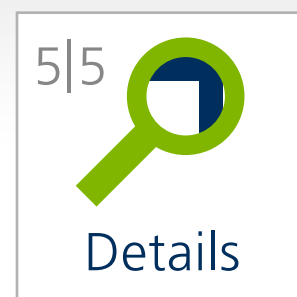
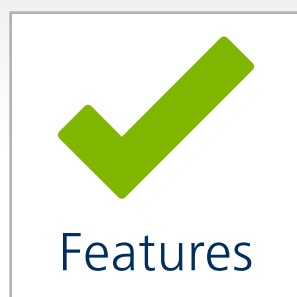

Performance data

Length	Heat output ¹⁾					Sound pressure level ²⁾	Sound power level
	at LPHW 75/65 °C	at LPHW 55/45 °C	at LPHW 90/70 °C	at LPHW 82/71 °C	at LPHW 40/30 °C		
[mm]	[W]	[W]	[W]	[W]	[W]	[dB(A)]	[dB(A)]
800	321 - 851	169 - 516	404 - 1018	374 - 960	71 - 261	<20 - 34	<28 - 42
1100	497 - 1317	261 - 797	625 - 1575	579 - 1484	109 - 404	<20 - 36	<28 - 44
1400	646 - 1713	340 - 1037	813 - 2048	753 - 1931	142 - 525	<20 - 37	<28 - 45
1700	971 - 2574	510 - 1559	1221 - 3078	1132 - 2902	213 - 789	<20 - 39	<28 - 47
2000	1221 - 3237	642 - 1960	1536 - 3872	1424 - 3650	268 - 992	<20 - 40	<28 - 48

¹⁾ at RT = 20 °C

²⁾ The sound pressure levels were calculated with an assumed room insulation of 8 dB(A). This corresponds to a distance of 2 m, a room volume of 100 m³ and a reverberation time of 0.5 s.

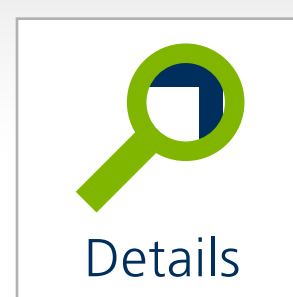
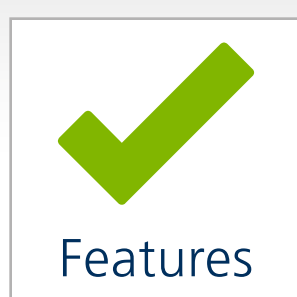

Dimensions

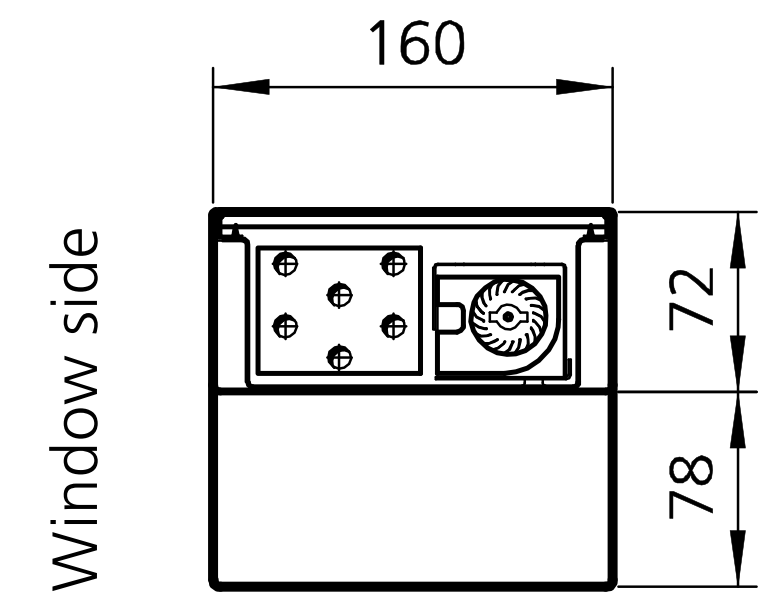
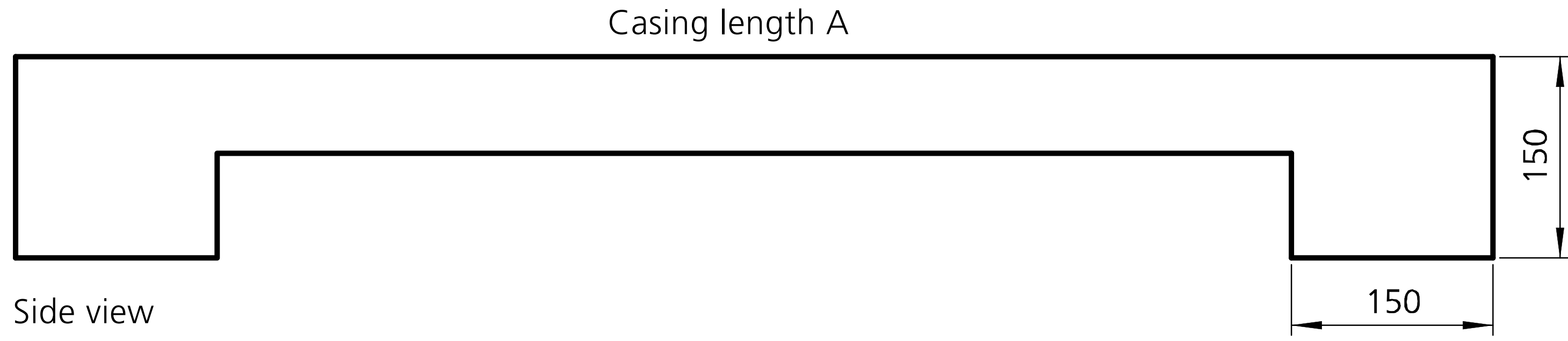

Cross section shown with orthogonal grille

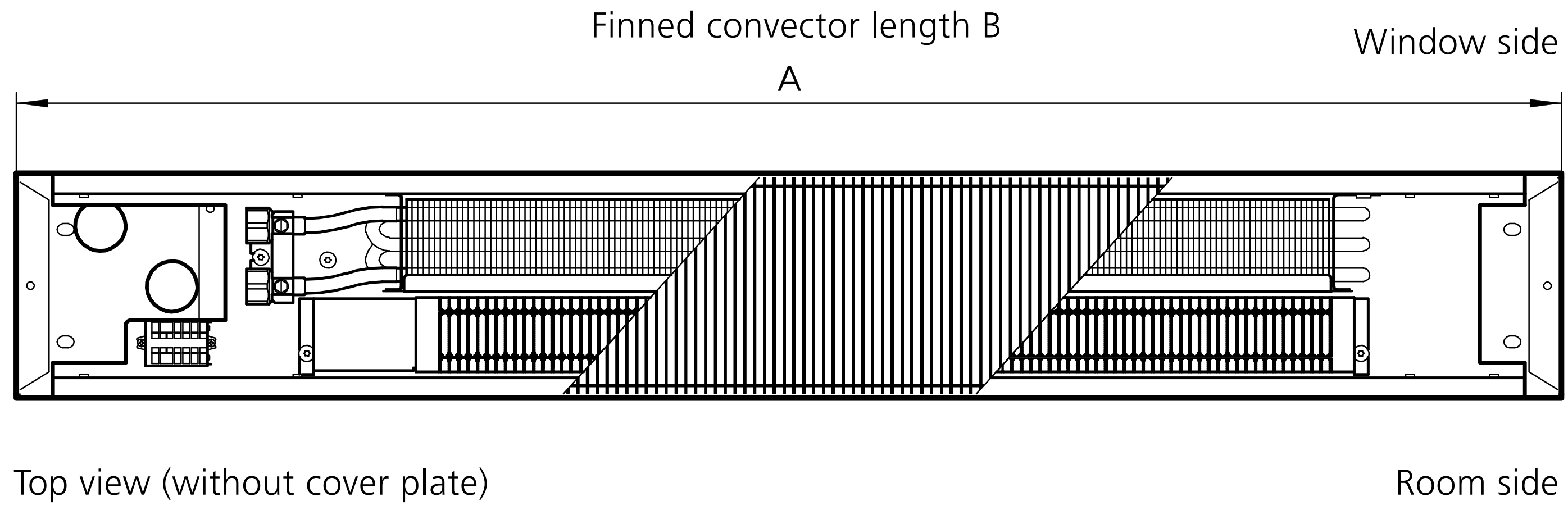

Casing length A	Finned convector length B
[mm]	[mm]
800	430
1100	665
1400	865
1700	1300
2000	1635

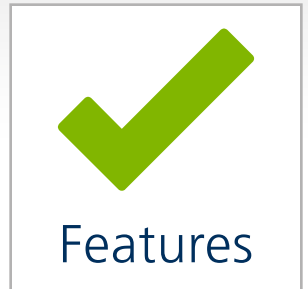

Benefits for you!

Kampmann offers you the following service benefits:

- ▶ on-site consultation
- ▶ diverse sampling
- ▶ planning support
- ▶ detailed discussions
- ▶ site-surveys
- ▶ personal training
- ▶ After Sales Service

Find your contact person here:

[Kampmann.eu/contact](https://www.kampmann.eu/contact)

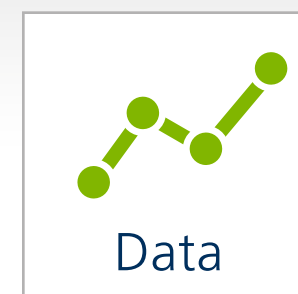
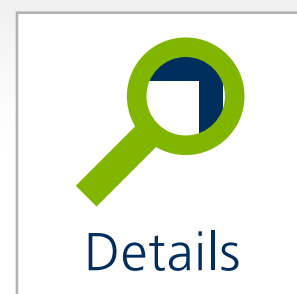
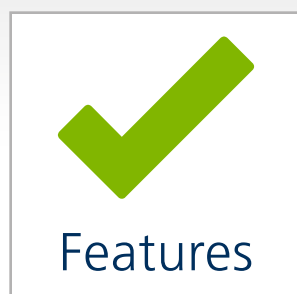

Best solutions. Best support.

Kampmann.eu

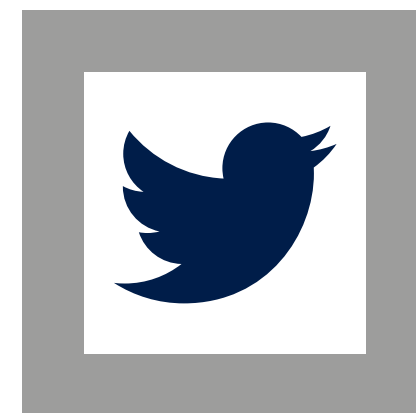

Kampmann GmbH

Friedrich-Ebert-Str. 128 – 130

49811 Lingen (Ems)

Germany

T +49 591 7108-660

T +49 591 7108-173

E export@kampmann.de

W Kampmann.eu

